

## The Best Relaytion



## HF3 Relay

High performance low cost plastic sealed  
high frequency relay for 50 and 75 Ohm systems,  
1 pole, polarized coil  
Surface Mount Technology (SMT)

Relay types: non latching  
latching 1 coil  
latching 2 coils

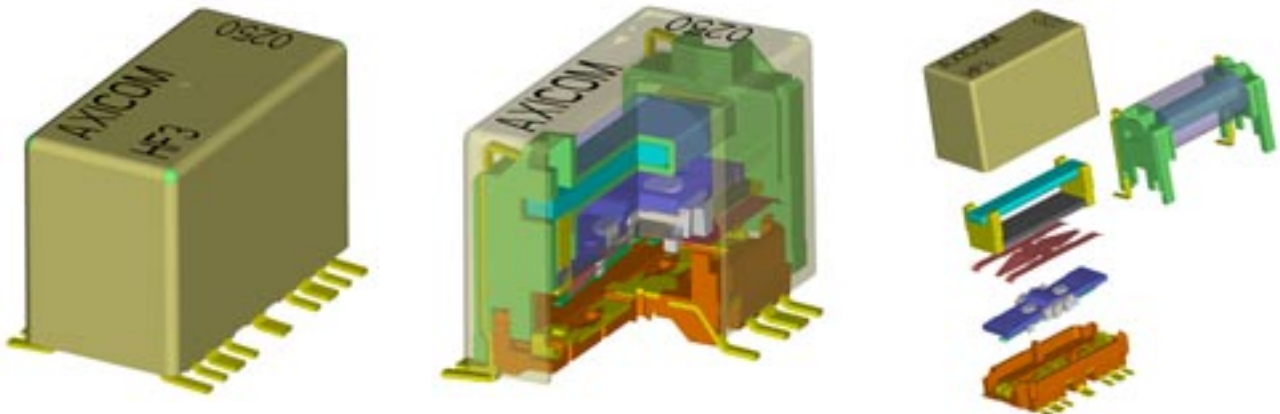

## Features

- Y-Design
- Frequency range DC to 3 GHz
- Impedance 50  $\Omega$  or 75  $\Omega$
- Small dimensions (14.6 mm x 7.2 mm x 10 mm)
- 1 change over contact (1 form C / SPDT)
- Immersion cleanable
- Low power consumption ( $\leq 140$  mW)

## Typical applications

- Cable modems and linecards/ CATV
- TAP's
- Measurement and test equipment ATE
- Satellite / audio / video tuners
- Wireless base stations and antennas

## European Directive conformance:

HF3 relay product conformance according to:

- Directive 2000/53/EC: ELV (End of Life of Vehicles)
- Directive 2002/95/EC: ROHS (Restrictions of the use of certain hazardous substances in electrical and electronic equipment)

Compliance is evidenced by written declaration from all raw material suppliers.

Tyco Electronics AXICOM only has responsibility for the proper processing of these materials.

Confirmation is valid for all date codes

**Dimension**

**50 Ohm Version**

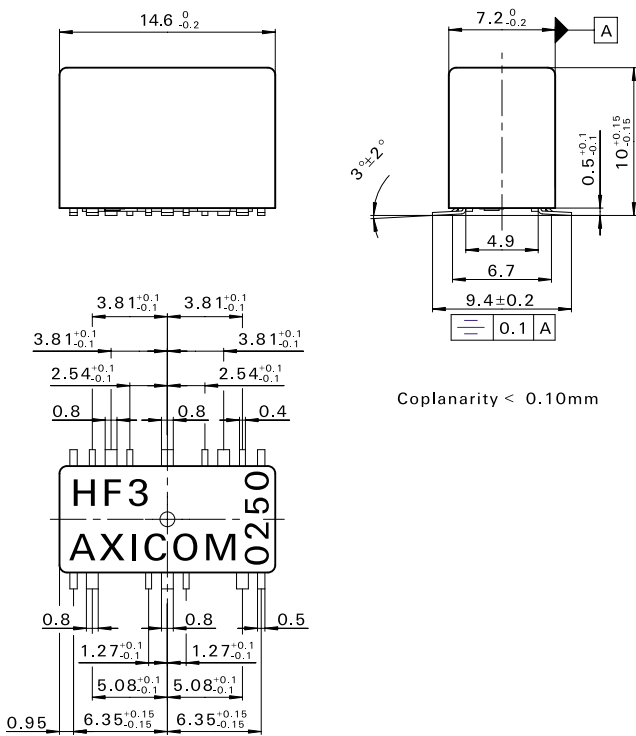

**75 Ohm Version**

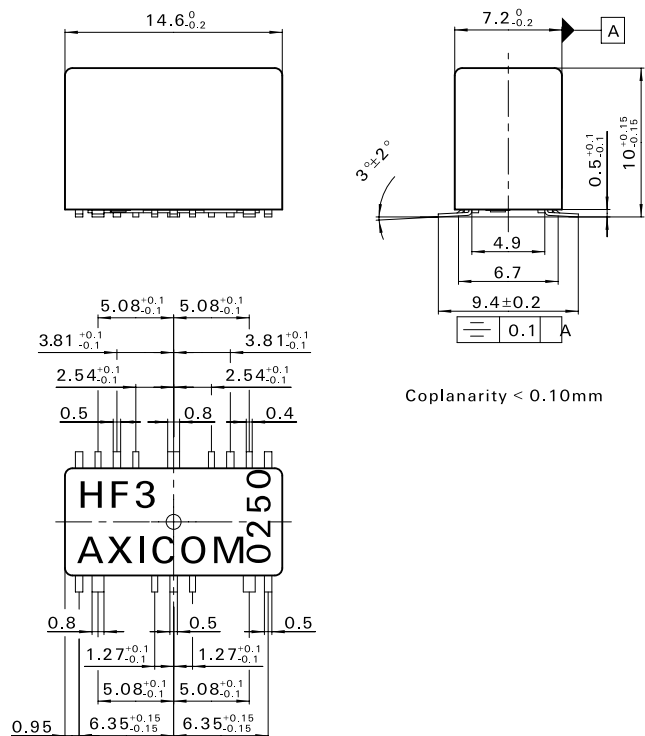

Coplanarity < 0.10mm

Coplanarity < 0.10mm

Dimensions in mm

**Solder pad layout**

**50 Ohm Version**

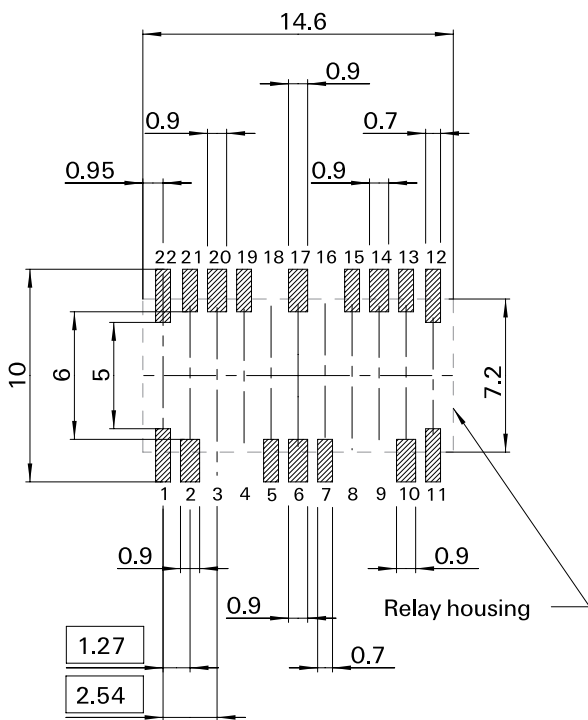

**75 Ohm Version**

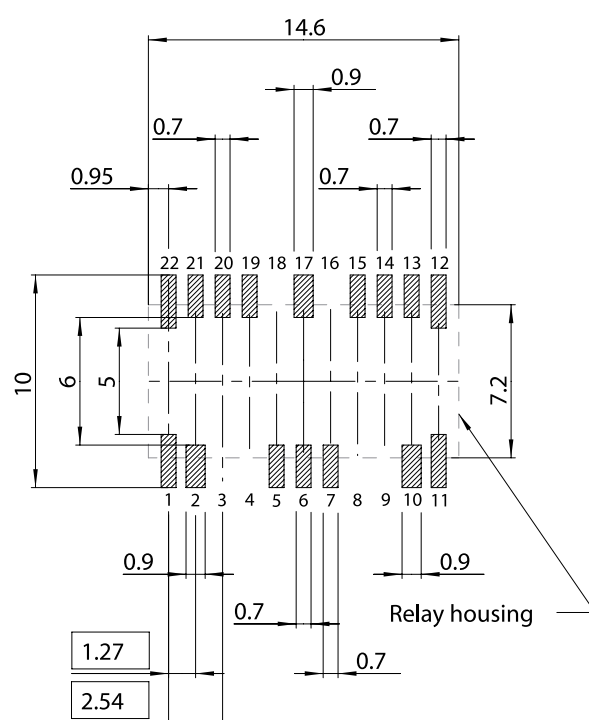

Dimensions in mm

View on the component side of the PCB (Top view)

## Terminal assignment

## Relay top view

Non-latching type,  
not energized condition

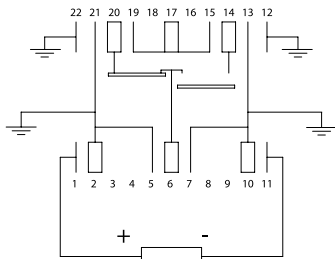

Latching type, 1 coil  
rest condition

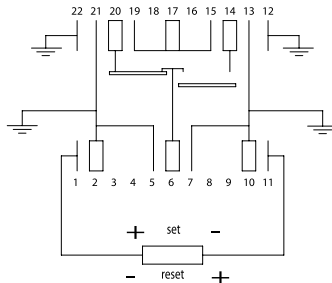

Latching type, 2 coils  
reset condition

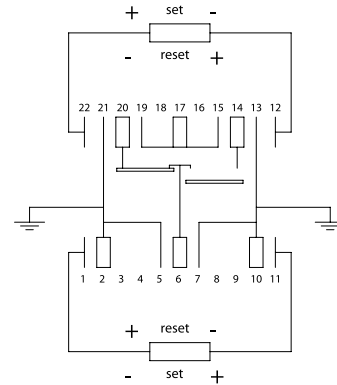

## Coil operating range

140 mW

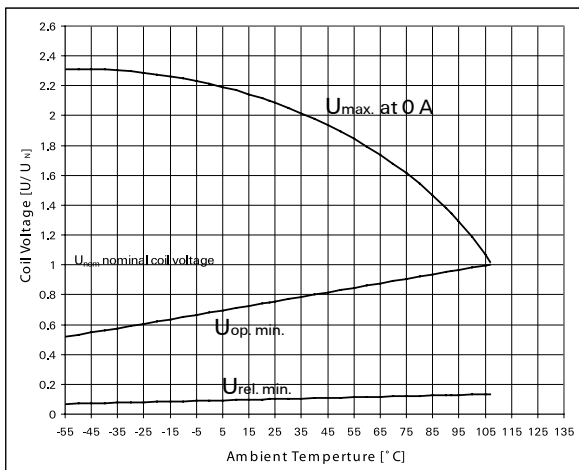

- $U_{nom}$  = Nominal coil voltage
- $U_{max.}$  = Upper limit of the operative range of the coil voltage (limiting voltage)
- $U_{op. min.}$  = Lower limit of the operative range of the coil voltage (reliable operate voltage)  
For latching relays  $U_{set min.}$  resp.  $U_{reset min.}$
- $U_{rel. min.}$  = Lower limit of the operative range of the coil voltage (reliable release voltage)

## Coil operating range

70 mW

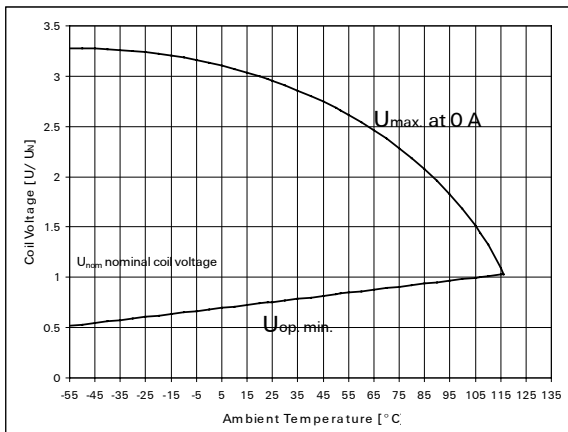

Coil Data (values at 23 °C)				Ordering Information			
Nominal voltage $U_{nom}$	Operate/set voltage range		Release/reset voltage Minimum	Coil power	Coil Resistance	Relay code	Tyco part number
	Minimum voltage $U_{min}$	Maximum voltage $U_{max}$	Vdc				
Vdc	Vdc	Vdc	Vdc	mW	$\Omega / \pm 10 \%$		

**Non-Latching, 1 coil, 50  $\Omega$  version**

3	2.25	6.50	0.30	140	64	HF3 51	0-1462051-1
4.5	3.38	9.80	0.45	140	145	HF3 52	1-1462051-6
5	3.75	10.90	0.50	140	178	HF3 53	0-1462051-2
6	4.50	13.00	0.60	140	257	HF3 54	1-1462051-7
9	6.75	19.60	0.90	140	574	HF3 55	0-1462051-3
12	9.00	26.10	1.20	140	1028	HF3 56	0-1462051-4
24	18.00	52.30	2.40	140	4114	HF3 57	0-1462051-5

**Latching, 1 coil, 50  $\Omega$  version**

3	2.25	9.20	2.25	70	128	HF3 71	0-1462051-6
4.5	3.38	13.85	3.38	70	289	HF3 72	1-1462051-8
5	3.75	15.30	3.75	70	357	HF3 73	0-1462051-7
6	4.50	18.50	4.50	70	514	HF3 74	1-1462051-9
9	6.75	27.70	6.75	70	1157	HF3 75	0-1462051-8
12	9.00	37.00	9.00	70	2057	HF3 76	0-1462051-9
24	18.00	74.00	18.00	70	8228	HF3 77	1-1462051-0

**Latching, 2 coils, 50  $\Omega$  version**

3	2.25	6.50	2.25	140	64	HF3 91	1-1462051-1
4.5	3.38	9.80	3.38	140	145	HF3 92	2-1462051-0
5	3.75	10.90	3.75	140	178	HF3 93	1-1462051-2
6	4.50	13.00	4.50	140	257	HF3 94	2-1462051-1
9	6.75	19.60	6.75	140	574	HF3 95	1-1462051-3
12	9.00	26.10	9.00	140	1028	HF3 96	1-1462051-4
24	18.00	52.30	18.00	140	4114	HF3 97	1-1462051-5

**Non-Latching, 1 coil, 75  $\Omega$  version**

3	2.25	6.50	0.30	140	64	HF3 01	0-1462050-1
4.5	3.38	9.80	0.45	140	145	HF3 02	1-1462050-6
5	3.75	10.90	0.50	140	178	HF3 03	0-1462050-2
6	4.50	13.00	0.60	140	257	HF3 04	1-1462050-7
9	6.75	19.60	0.90	140	574	HF3 05	0-1462050-3
12	9.00	26.10	1.20	140	1028	HF3 06	0-1462050-4
24	18.00	52.30	2.40	140	4114	HF3 07	0-1462050-5

**Latching, 1 coil, 75  $\Omega$  version**

3	2.25	9.20	2.25	70	128	HF3 21	0-1462050-6
4.5	3.38	13.85	3.38	70	289	HF3 22	1-1462050-8
5	3.75	15.30	3.75	70	357	HF3 23	0-1462050-7
6	4.50	18.50	4.50	70	514	HF3 24	1-1462050-9
9	6.75	27.70	6.75	70	1157	HF3 25	0-1462050-8
12	9.00	37.00	9.00	70	2057	HF3 26	0-1462050-9
24	18.00	74.00	18.00	70	8228	HF3 27	1-1462050-0

**Latching, 2 coils, 75  $\Omega$  version**

3	2.25	6.50	2.25	140	64	HF3 41	1-1462050-1
4.5	3.38	9.80	3.38	140	145	HF3 42	2-1462050-0
5	3.75	10.90	3.75	140	178	HF3 43	1-1462050-2
6	4.50	13.00	4.50	140	257	HF3 44	2-1462050-1
9	6.75	19.60	6.75	140	574	HF3 45	1-1462050-3
12	9.00	26.10	9.00	140	1028	HF3 46	1-1462050-4
24	18.00	52.30	18.00	140	4114	HF3 47	1-1462050-5

Values given are valid for the coil at ambient temperature of 23 °C after preenergizing with nominal voltage without contact current.

## Contact Data

Number of contacts and type	1 changeover (SPDT)
Contact material	Gold
Limiting continuous current at max. ambient temperature	1 A
Maximum switching current	100 mA
Maximum switching voltage	60 Vdc / 125 Vac
Maximum switching capacity	10 W / 20 VA / 10 W (2.5 GHz)
Initial contact resistance at 10 mA / 20 mV	< 100 mΩ
Mechanical endurance	10 <sup>7</sup> operations

## Isolation

Isolation resistance at 500 VDC	> 100 MΩ
Dielectric test voltage (1 min)	
between coil and contacts	1000 Vrms
between open contacts	600 Vrms
Surge voltage resistance according to FCC 68 (10 / 160 μs) and (2 / 10 μs)	
between coil and contacts	1500 V
between open contacts	1000 V

## General Data

Operate time at Unom typ./max.	3 ms / 5 ms
Reset time (latching) at Unom typ. / max.	3 ms / 5 ms
Release time without diode in parallel (non-latching) typ./max.	2 ms / 4 ms
Release time with diode in parallel (non-latching) typ./max.	4 ms / 6 ms
Bounce time at closing contact typ. / max.	1 ms / 3 ms
Maximum switching rate without load	50 operations/s
Ambient temperature	-55°C ... +85°C (106°C on request)
Thermal resistance	> 165 K/W
Maximum permissible coil temperature	125°C
Vibration resistance (function)	35 G 10 to 1000 Hz
Shock resistance, half sinus, 11 ms	50 G (function) 150 G (damage)
Degree of protection / Environmental protection	immersion cleanable, IP 67 / RT III
Needle flame test	application time 20 s, bruning time < 15 s
Mounting position	any
Processing information	Ultrasonic cleaning is not recommended
Weight (mass)	max. 2,5 g
Terminal surface	SnCu 0.7
Moisture sensitive level (JEDEC J-STD-020B)	MSL 3
Resistance to soldering heat	260°C/10 s

## High Frequency Data

RF characteristics	50 Ω	75 Ω
Isolation at 100 MHz / 900 MHz / 3 GHz	-80dB / -72dB / -45dB	-80dB / -72dB / -40dB <sup>1</sup>
Insertion loss at 100 MHz / 900 MHz / 3 GHz	-0.03dB / -0.12dB / -0.35dB	-0.03dB / -0.12dB / -0.4dB <sup>1</sup>
V.S.W.R. at 100 MHz / 900 MHz / 3 GHz	1.05 / 1.15 / 1.20	1.05 / 1.20 / 1.40 <sup>1</sup>

<sup>1</sup> Values given at frequency of 2.5 GHz

### 50 Ohm version

### 75 Ohm version

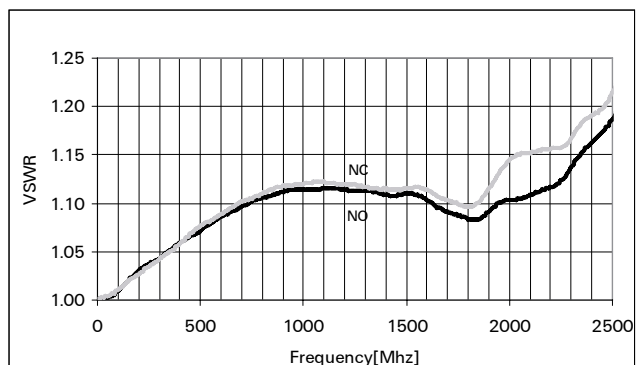
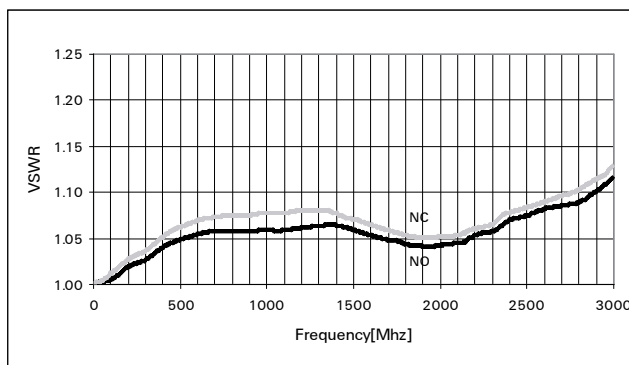
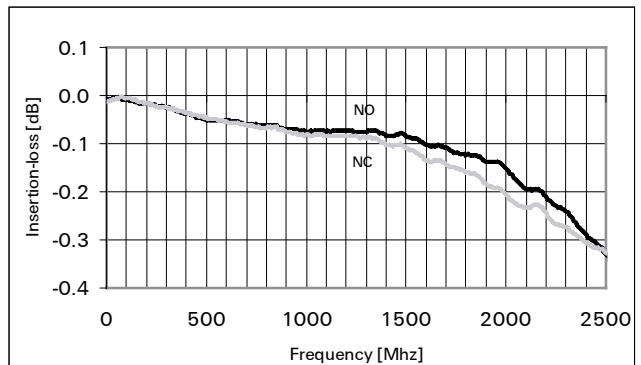
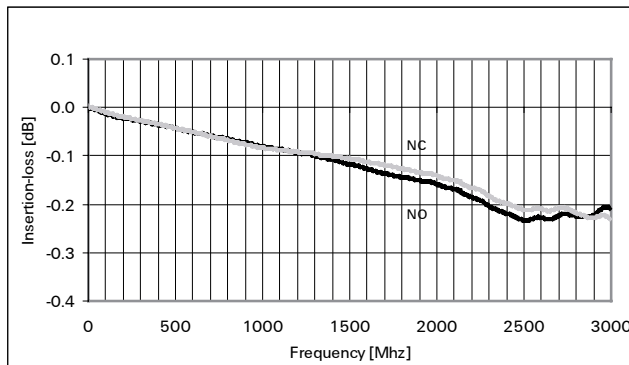
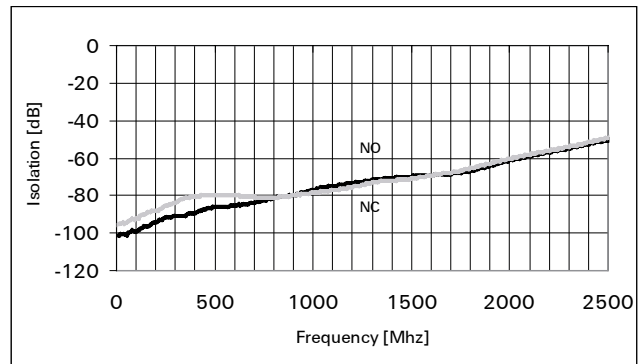
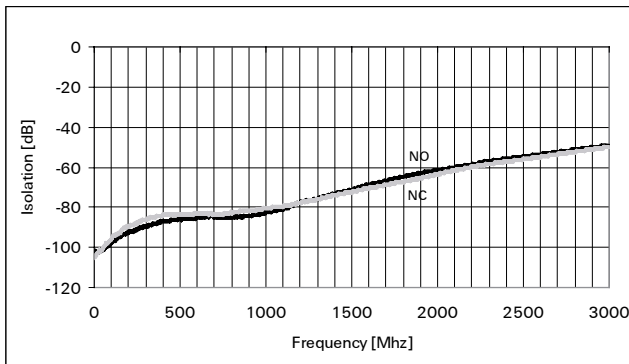

**Recommended soldering conditions**

Soldering conditions according IEC 60058-2-58 and IPC/JEDEC J-STD-020B

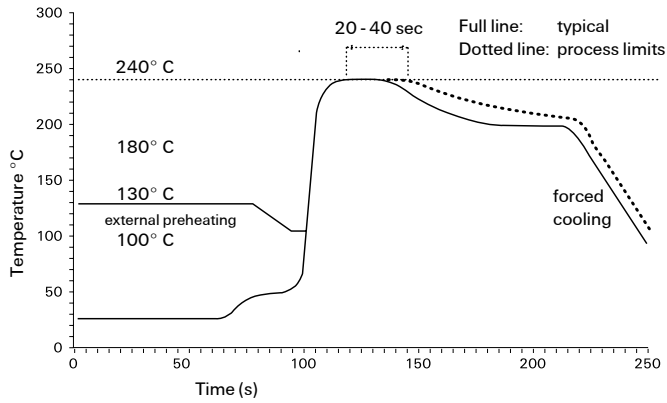

Vapor Phase Soldering: Temperature/Time Profile (Lead and Housing Peak Temperature)

**Resistance to soldering heat - Reflow profile**

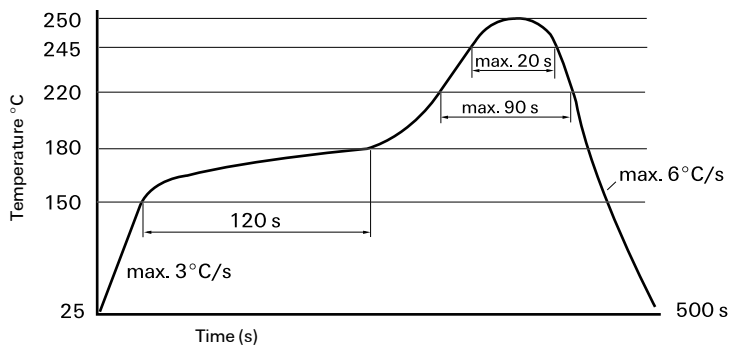

Infrared Soldering: Temperature/Time Profile (Lead and Housing Peak Temperature)

**Recommended reflow soldering profile**

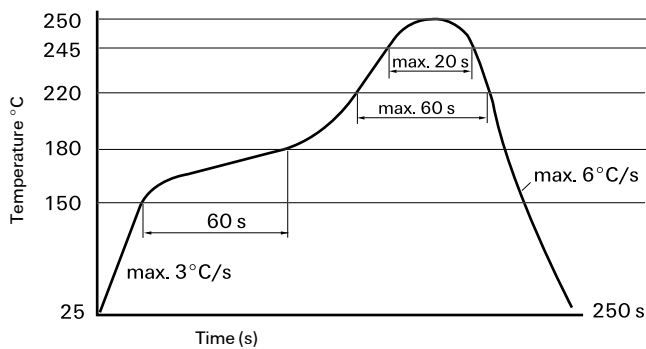

Infrared Soldering: Temperature/Time Profile (Lead and Housing Peak Temperature)





## IM Relays

4<sup>th</sup> generation slim line – low profile polarized 2 c/o telecom relay with bifurcated contacts, available as non latching or latching relay with 1 coil. Nominal voltage range from 1.5... 24 V, coil power consumption of 140... 200 mW, latching relays with 1 coil 100 mW. The IM relay is available as through hole and surface mount type (J-Legs and Gull Wings) and capable to switch loads up to 60 W/62,5 VA. Dielectric strength fulfills the Bellcore requirements according GR 1089 (2,5 kV – 2 / 10 μs) and FCC part 68 (1,5 kV – 10 / 160 μs). The IM relay is CECC/IECQ approved and certified in accordance with IEC/EN 60950 and UL 1950. Dimensions approx. 10 x 6 mm board space and 5,65 mm height.

## P2 Relays

3<sup>rd</sup> generation polarized 2 c/o telecom relay with bifurcated contacts, available as non latching or latching relay with 1 or 2 coils. Nominal voltage range from 3 ... 24 V, coil power consumption 140 mW, latching relays with 1 coil 70 mW. The P2 Relay is available as through hole or surface mount type and capable to switch currents up to 5 A. Dielectric strength fulfills the Bellcore requirements according GR 1089 (2,5 kV – 2 / 10 μs) and FCC part 68 (1,5 kV – 10 / 160 μs). Dimensions approx. 15 x 7,5 mm board space and 10 mm height.

## FX Relays

3<sup>rd</sup> generation polarized 2 c/o telecom relay with bifurcated contacts, available as non latching or latching relay with 1 coil. Nominal voltage range from 3 ... 48 V, coil power consumption of 80 ... 260 mW for the high sensitive version, 140... 300 mW for the standard version, latching relays with 1 coil 100 mW. The FX2 relay is available as through hole type and capable to switch loads up to 60 W/62,5 VA. Dielectric strength fulfills the Bellcore requirements according GR 1089 (2,5 kV – 2 / 10 μs) and FCC part 68 (1,5 kV – 10 / 160 μs). The FX2 is CECC/IECQ approved and certified in accordance with IEC/EN 60950 and UL1950. Dimensions approx. 15 x 7,5 mm board space and 10,7 mm height.

## FT2 / FU2 Relays

3<sup>rd</sup> generation non polarized, non latching 2 c/o telecom relay with bifurcated contacts. Nominal voltage range from 3 ... 48 V, coil power consumption 200 ... 300 mW. Most sensitive 48 V relay. Available as through hole and surface mount type. Dielectric strength fulfills the Bellcore requirements according GR 1089 (2,5 kV – 2 / 10 μs) and FCC part 68 (1,5 kV – 10 / 160 μs). The FT2/FU2 is CECC/IECQ approved and certified in accordance with IEC/EN 60950 and UL1950. Dimensions approx. 15 x 7,5 mm board space and 10 mm height.

## FP2 Relays

3<sup>rd</sup> generation polarized 2 c/o telecom relay with bifurcated contacts, available as non latching or latching relay with 1 or 2 coils. Nominal voltage range from 3 ... 48 V, coil power consumption of 80 ... 260 mW for the high sensitive version, 140... 300 mW for the standard version, latching relays with 1 coil 100 mW. The FP2 Relay is available as through hole type and capable to switch loads up to 30 W/62,5 VA. Dielectric strength fulfills FCC part 68 (1,5 kV – 10 / 160 μs). The FP2 is CECC/IECQ approved. Dimensions approx. 14 x 9 mm board space and 5 mm height.

## MT2 / MT4

2<sup>nd</sup> generation non polarized, non latching 2 c/o and 4 c/o telecom and signal relay with bifurcated contacts. Nominal voltage range from 4.5 ... 48 V, coil power consumption 150/200/300/400 and 550 mW, and 300 mW (MT4). Dielectric strength fulfills the requirements according FCC part 68 (1,5 kV – 10 / 160 μs) for both and the Bellcore requirements according GR 1089 (2,5 kV – 2 / 10 μs) the MT4 only. Dimensions MT2 approx. 20 x 10 mm board space and 11 mm height, MT4 approx. 20 x 15 mm board space and 11 mm height.

## D2n Relays

2<sup>nd</sup> generation non polarized 2 c/o relay for telecom and various other applications. Nominal voltage range from 3 ... 48 V, coil power consumption from 150 ... 500 mW. The D2n relay is capable to switch currents up to 3 A. Dielectric strength fulfills the requirements according FCC part 68 (1,5 kV – 10 / 160 μs). Dimensions approx. 20 x 10 mm board space and 11,5 mm height.

## P1 Relays

Extremely sensitive, polarized 1 c/o relay with bifurcated contacts for a wide range of applications, available as non latching or latching relay with 1 or 2 coils. Nominal voltage range from 3 ... 24 V, coil power consumption 65 mW, latching relays with 1 coil 30 mW. The P1 relay is available as through hole or surface mount type and capable to switch currents up to 1 A. Dielectric strength fulfills the requirements according FCC part 68 (1,5 kV – 10 / 160 μs). Dimensions approx. 13 x 7,6 mm board space and 7 mm height for THT or 8 mm height for SMT version.

## W11 Relays

Low cost, non polarized 1 c/o relay for various applications. Nominal voltage range from 3 ... 24 V, coil power consumption 450 mW, sensitive versions 200 mW. The W11 relay is capable to switch currents up to 3 A. Dielectric strength 1000 Vrms. Dimensions approx. 15,6 x 10,6 mm board space and 11,5 mm height.

## Reed Relays

High sensitive, non polarized relay for telecom and various other applications, available with 1 n/o, 2 n/o or 1 c/o contacts. Nominal voltage range from 5 ... 24 V, coil power consumption 50...280 mW for 1 n/o and 125 ... 280 mW for 2 n/o or 1 c/o versions. Reedrelays are available in DIP or SIL housing and capable to switch currents up to 0,5 A. Integrated diode and/or electrostatic shield optional. Dielectric strength 1500 Vdc. Dimensions approx. 19,3 x 7 mm board space and 5 ... 7,5 mm height for DIP or 19,8 x 5 mm board space and 7,8 mm height for SIL version.

## Cradle Relays

Extremely reliable and mature relay family of 1<sup>st</sup> generation for various signal switching applications. Available as non polarized, polarized / latching and relay with AC coil. The benefit is the possibility of combining various contact sets from 1 up to 6 poles, single and bifurcated contacts, different contact materials with a coil voltage range from 1,5 Vdc to 220 Vac. Cradle relays are available as dust protected and hermetically sealed versions, with plug in or solder terminals and are capable to switch currents up to 5 A. Forcibly guided (linked) contact sets optional. Dielectric strength 500 Vrms. Dimensions from approx. 19 x 24 to 19x35 mm board space and 30 mm height.

## Other Relays

We offer a variety of different relay families for maintenance and replacement purposes. These relays are up to 60 years old now, such as Card Relay SN (V23030 / V23031 series), Small General Purpose Relay (V23006 series), Small Polarized Relay (V23063 ... V23067 and V23163 ... V23167 series). Accessories like sockets, hold down springs, etc. optional.

## HF3 Relay

High performance low cost RF relay with excellent RF characteristics. Available with an impedance of 50 and 75 Ohm. Suitable for frequencies up to 3 GHz. Actually smallest RF relay available combining small size, excellent RF performance and SMD solderability. Available as non latching or latching relay with 1 or 2 coils and a nominal coil voltage range from 3 ... 24 V, coil power consumption 140 mW, latching relays with 1 coil 70 mW. Dimensions 14,6 x 7,3 x 10 mm.



Tyco Electronics AXICOM Ltd.  
Seestrasse 295 - P.O. Box 220  
CH-8804 Au-Wädenswil / Switzerland  
Phone +41 1 782 9111  
Fax +41 1 782 9080  
E-mail: [axicom@tycoelectronics.com](mailto:axicom@tycoelectronics.com)



Tyco Electronics  
Paulsternstrasse 26  
D-13629 Berlin / Germany  
Phone +49 30 386 38573  
Fax +49 30 386 38575  
E-mail: [axicom@tycoelectronics.com](mailto:axicom@tycoelectronics.com)



Tyco Electronics EC Trutnov s.r.o.  
Komenského 821  
CZ-541 01 Trutnov / Czech Republic  
E-mail: [axicom@tycoelectronics.com](mailto:axicom@tycoelectronics.com)

Tyco Electronics Corporation  
POB 3608,  
Harrisburg, PA 17105, USA  
Phone +1 800-522-6752